

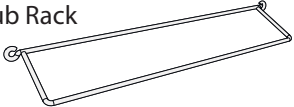







STEM Storage Cart

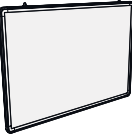

Assembly Guide Amendment This replaces Step 2 of your LW430 assembly guide.

For assistance, please contact us:
1-800-267-8494 or info@copernicused.com
Have your packing slip ready for reference

Contents - LWSTEM-CB	
Tiny Tub Rack 2x 	Tiny Tub 8x 
Chart Loop Hook 2x (31062) 	Whiteboard 1x (AC455) 
(G) M6 x 19mm Screw 4x (43219) 	
(H) M6 Lock Washer 4x (43273) 	

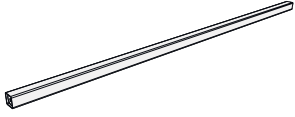
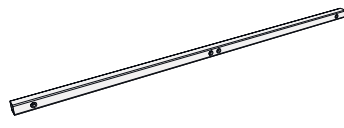
2.1	Actual Size:	 (A) 14x	 (B) 8x	 (C) 14x
	You will need: (Not to Scale)	 Bent Stretcher 2x	 Straight Stretcher 2x	 Straight Stretcher with Threaded Inserts 1x

Attach Stretchers & Chart Loop Hooks

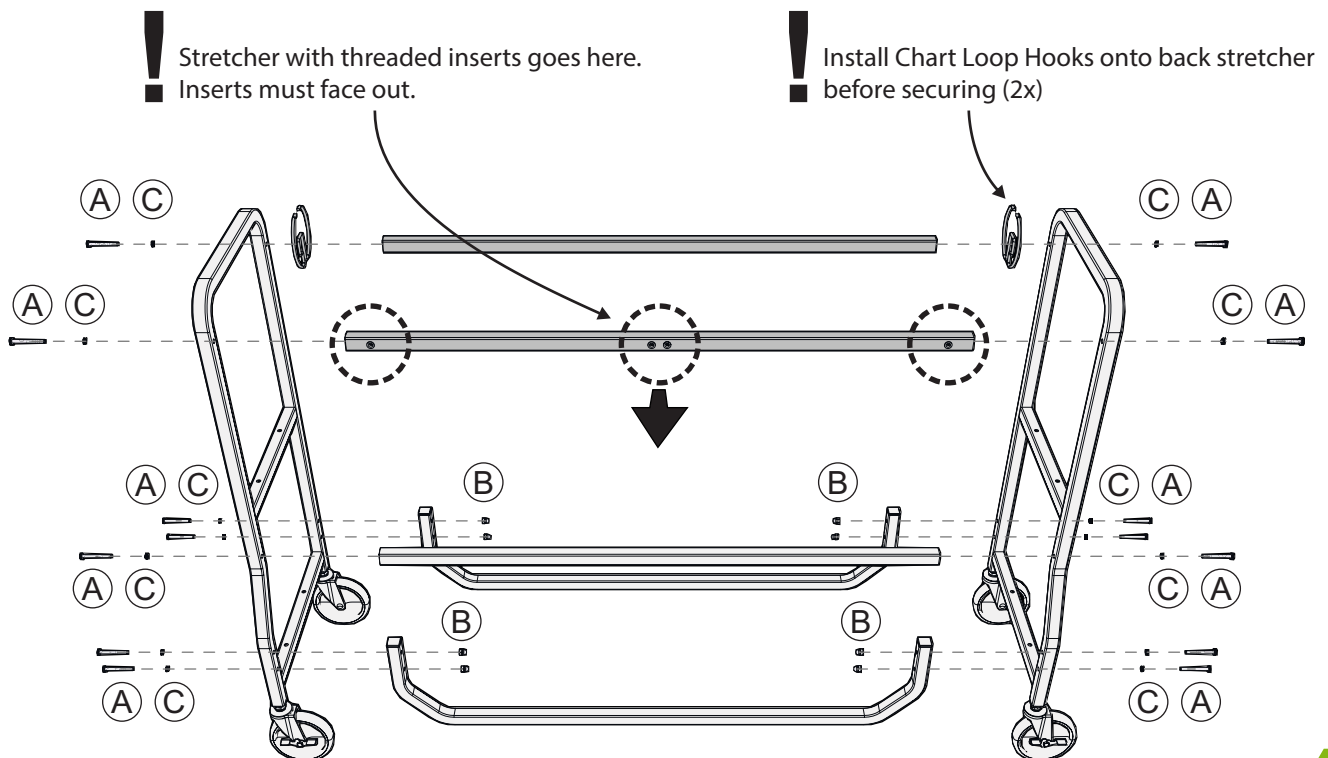

2.2

Actual Size:

You will need: (Not to Scale)

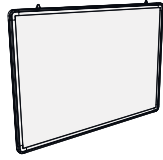

Whiteboard
1x

Attach Hanging Whiteboard

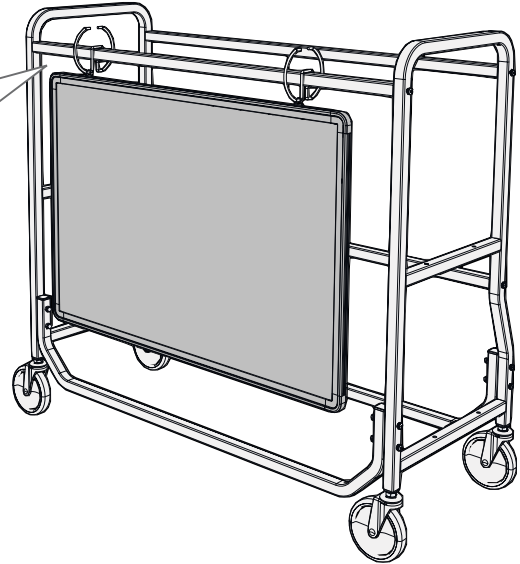
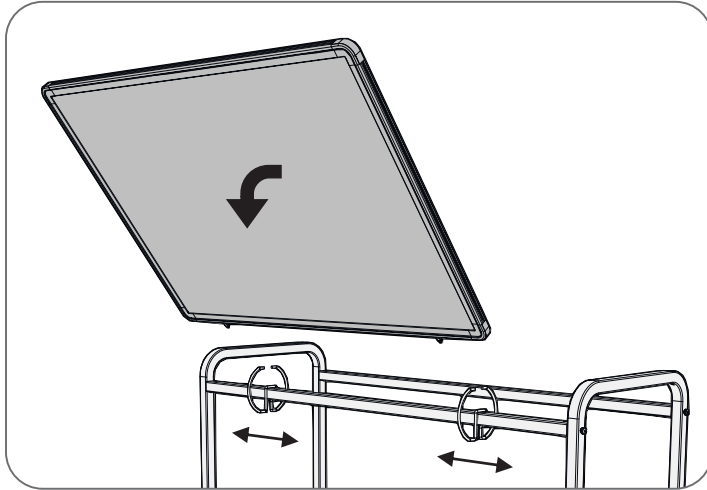

2.3

Actual Size:



You will need: (Not to Scale)

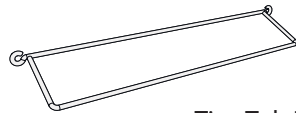

Tiny Tub Rack
2x

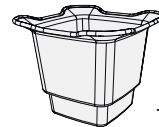

Tiny Tub
8x

Install Tiny Tub Racks & Tubs

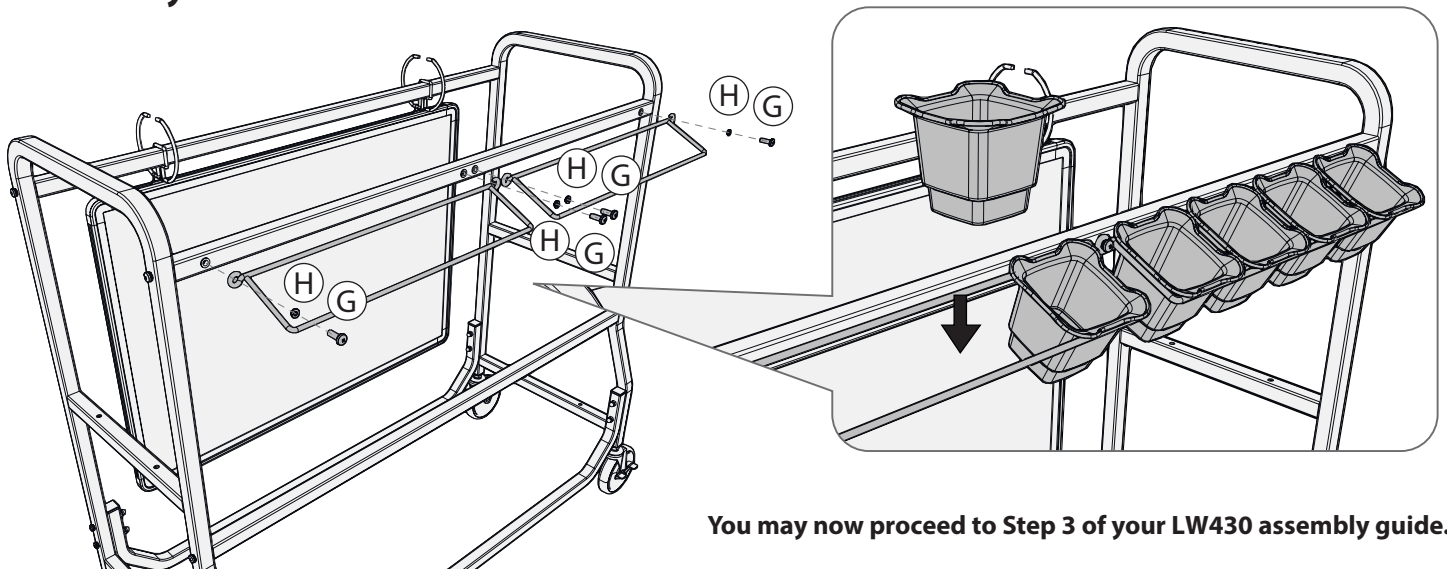

You may now proceed to Step 3 of your LW430 assembly guide.