



Assembly Guide

Check out our other products online at www.copernicused.com

For assistance, please contact us by telephone at 1-800-267-8494 or email at info@copernicused.com.

Have your packing slip ready for reference.



Phys-Ed Cart

Dear Educator,

Thank you for purchasing the Phys-Ed Cart. We hope it meets your expectations and you and your students enjoy using it at your school.

Every day we see and hear stories of teachers going above and beyond to help students thrive. Thank you so much for all you do – you are awesome, and you make a difference.

Thank you for inspiring us.

If you have any questions, concerns or ideas on how we can improve please let us know by contacting our Customer Solutions Ninjas at 1-800-267-8494 or info@copernicused.com.

Happy teaching,

Kaylyn Belcourt, President
kaylyn@copernicused.com



We do not inherit the earth from our ancestors, we borrow it from our children.

- NATIVE AMERICAN PROVERB

Change is the end result of all true learning.

- LEO BUSCAGLIA

What you leave behind is not what is engraved in stone monuments, but what is woven into the lives of others.

- PERICLES

Education is the most powerful weapon which you can use to change the world.

- NELSON MANDELA

For missing parts and other issues regarding your product:

Please contact Customer Service, where we will be happy to help.
Telephone: 1-800-267-8494, Monday - Friday 8:00am - 4:30 pm EST
Email: info@copernicused.com

Need Support?
Have a Question?



Email Customer Service

Check out some of our other great products!



www.copernicused.com



Register your Product

Registering your warranty ensures we have all the information we need to make any future warranty claims quick and easy. Please visit www.copernicused.com/warranty and complete the form within 10 business days from product assembly. By registering your product, you will be entered into a draw to win Copernicus product.



Make a Warranty Claim

We offer a Lifetime Warranty on almost everything we make. Please call 1-800-267-8494 or email info@copernicused.com to start your warranty claim. Proof of purchase will be required upon warranty claim (i.e. copy of invoice).

Tips for Assembly

Before You Begin:

- Lay out and identify all of the included parts.
- The hardware has been packed according to step in one bag.
- Read the assembly guide over once to familiarize yourself with them.

As You Assemble the Unit:

- Follow the steps in sequence.
- Before beginning each step, find the part(s) that you need for that step.
- The title of each step states what you will be doing. Review the text and the pictures as you build the unit.

Watch for These Helpful Symbols:



2-Person Task

For safety, please have someone help you when working on steps displaying this symbol.



The symbol denotes a step needing extra attention to ensure it is done correctly.



Important Information! Warning!

Please read the warnings below for important safety information regarding your product. Failure to read these warnings or to follow the instructions below could result in personal injury or damage to your product that could void your warranty.



Small Parts

In its unassembled state, this product contains parts that can be hazardous to small children. This product should be assembled by an adult.



Adult Supervision

This product is to be used under the supervision of an adult.



Climb Hazard

Do not climb on, hang from or suspend objects from any components of your product unless otherwise specified.



Indoor Use Only

This product is intended for indoor commercial use only. To reduce the risk of fire or electric shock, do not expose this product to rain or moisture. The internal components are not sealed from the environment.

Before beginning, you should have:

Additional tools required:



OR

10mm
Wrench

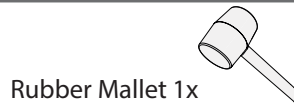

BC300-0

End Frame
2x

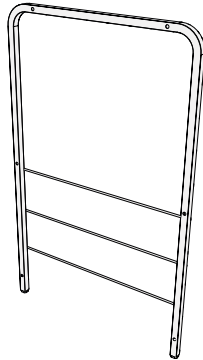

Stretcher
2x



Ball Rack Side Frame
2x

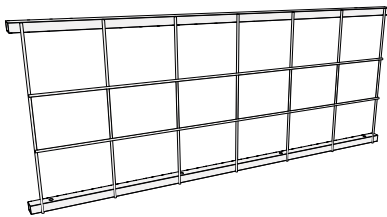

Ball Rack Bottom Frame
1x

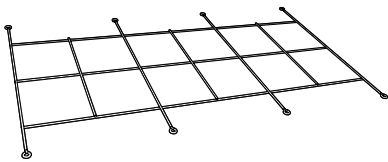

Hula Hoop Rack Wire
1x



Hula Hoop Rack Hook
2x

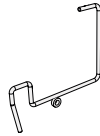

Casters
4x
2x locking
2x non-locking

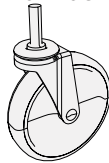

In BC300-0

Hardware
Actual Size

(A) M6 x 45mm
12x
(43245)



(B) M6 x 30mm
8x
(43230)



(C) M6 Lock Washer
20x
(43273)



(D) M6 Lock Nut
8x
(43275)



(E) M6 Acorn Nut
2x
(43271)



(F) M6 Flat Washer
2x
(432731)



Tools
(Not to Scale)

Allen Key
(43281)



BC300-CB

Open Tub
3x
(CC4068)

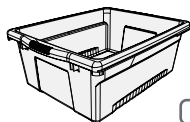

10 lbs Weight Limit

1

You will need: (Not to Scale)

Casters
2 x locking
2 x non-locking

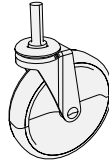

End Frame
2x



Insert Casters into Both End Frames

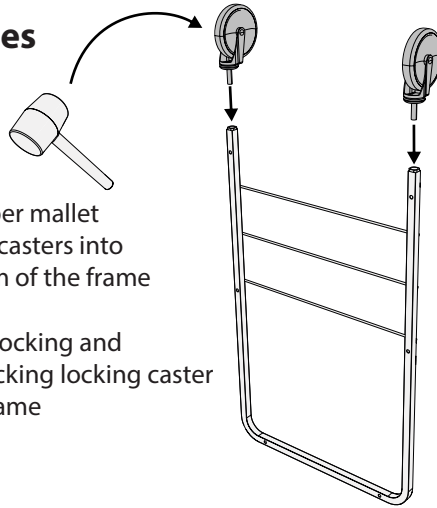

★ Use a rubber mallet to tap the casters into the bottom of the frame

Install 1 x locking and 1 x non-locking locking caster on each frame

2

Actual Size:

(A) M6 x 45mm
12x



(C) M6 Lock Washer
12x



You will need:
(Not to Scale)

Ball Rack Side Frame
2x

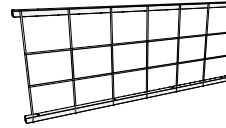

End Frame (with casters installed)
2x

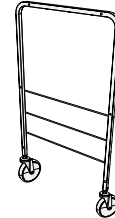

Stretcher
2x

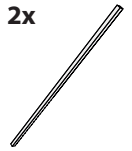

2-Person Task

Assemble Ball Rack Side Frames and Stretches to End Frames

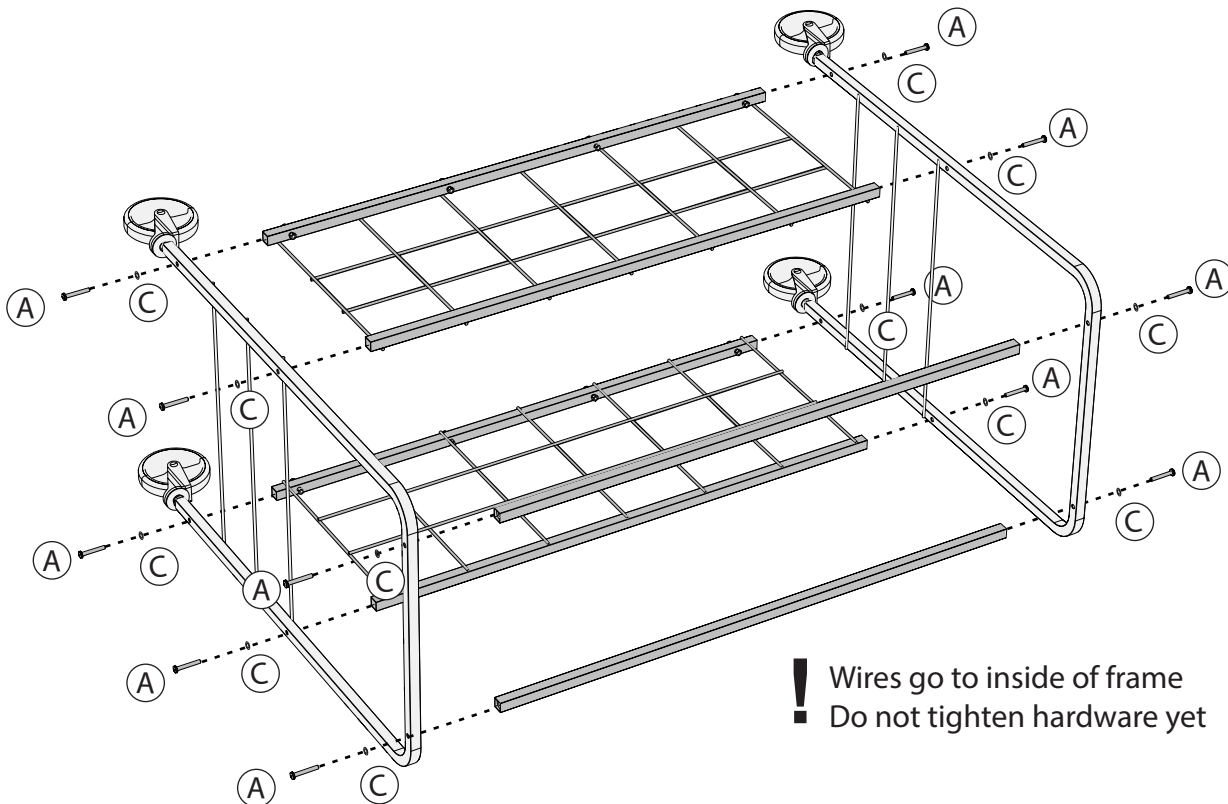

! Wires go to inside of frame
■ Do not tighten hardware yet

3

Actual Size:

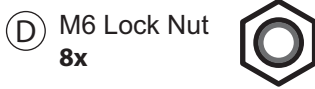
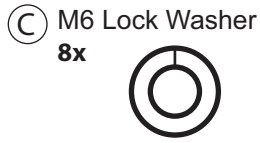
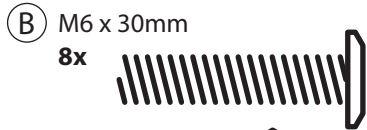

You will need: (Not to Scale)

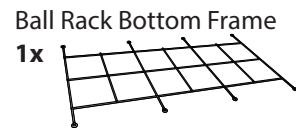

Install Ball Rack Bottom Frame

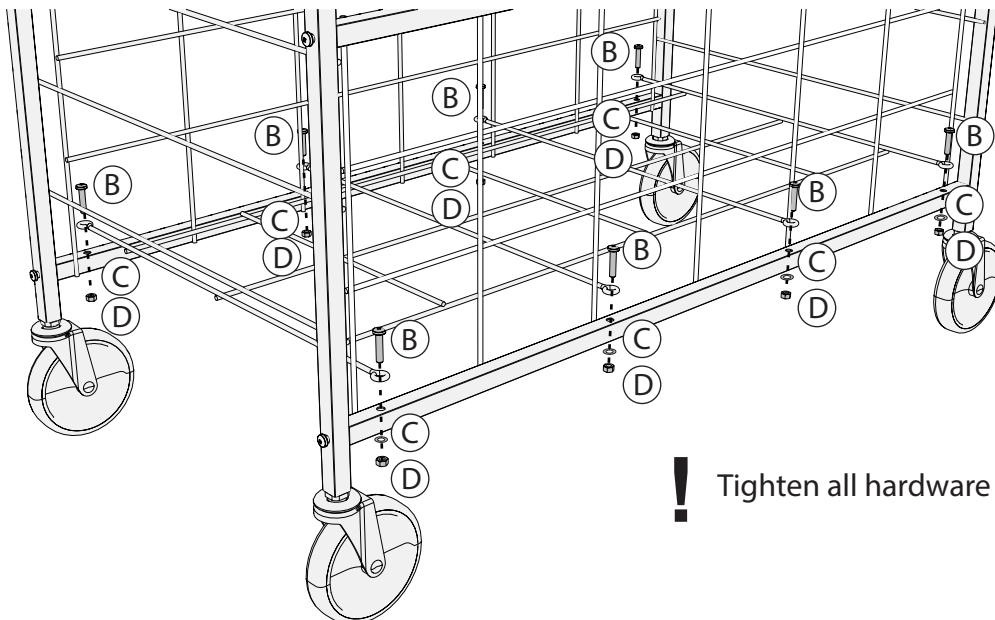
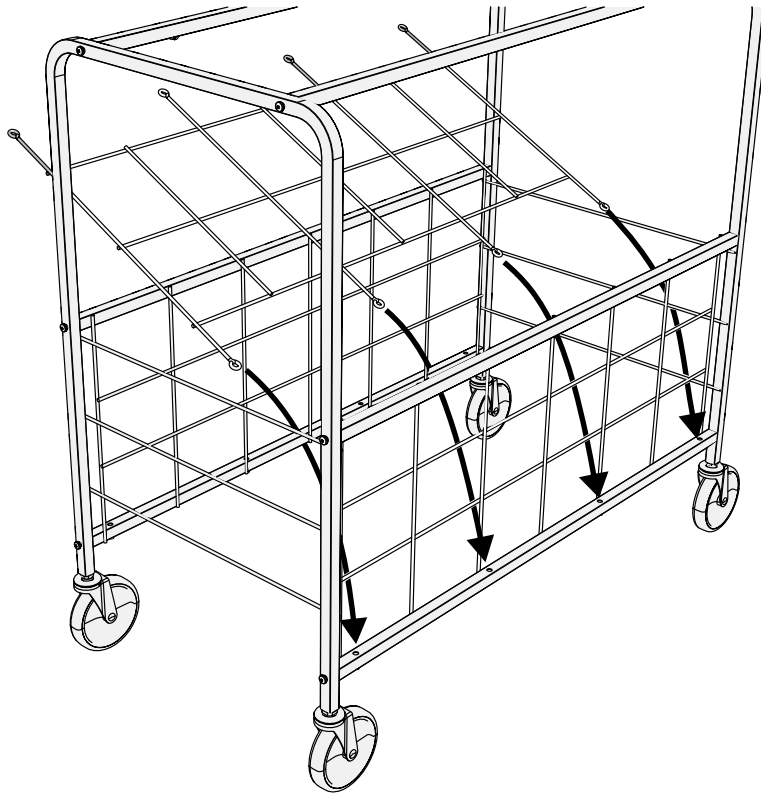

! Tighten all hardware now

4

Actual Size:

(E) M6 Acorn Nut
2x



(F) M6 Flat Washer
2x



You will need: (Not to Scale)

Hula Hoop Rack Hook
2x

Hula Hoop Rack Wire
1x

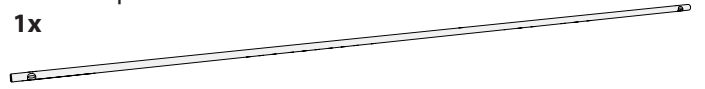

Assemble Hula Hoop Rack and Install on rear stretcher of cart

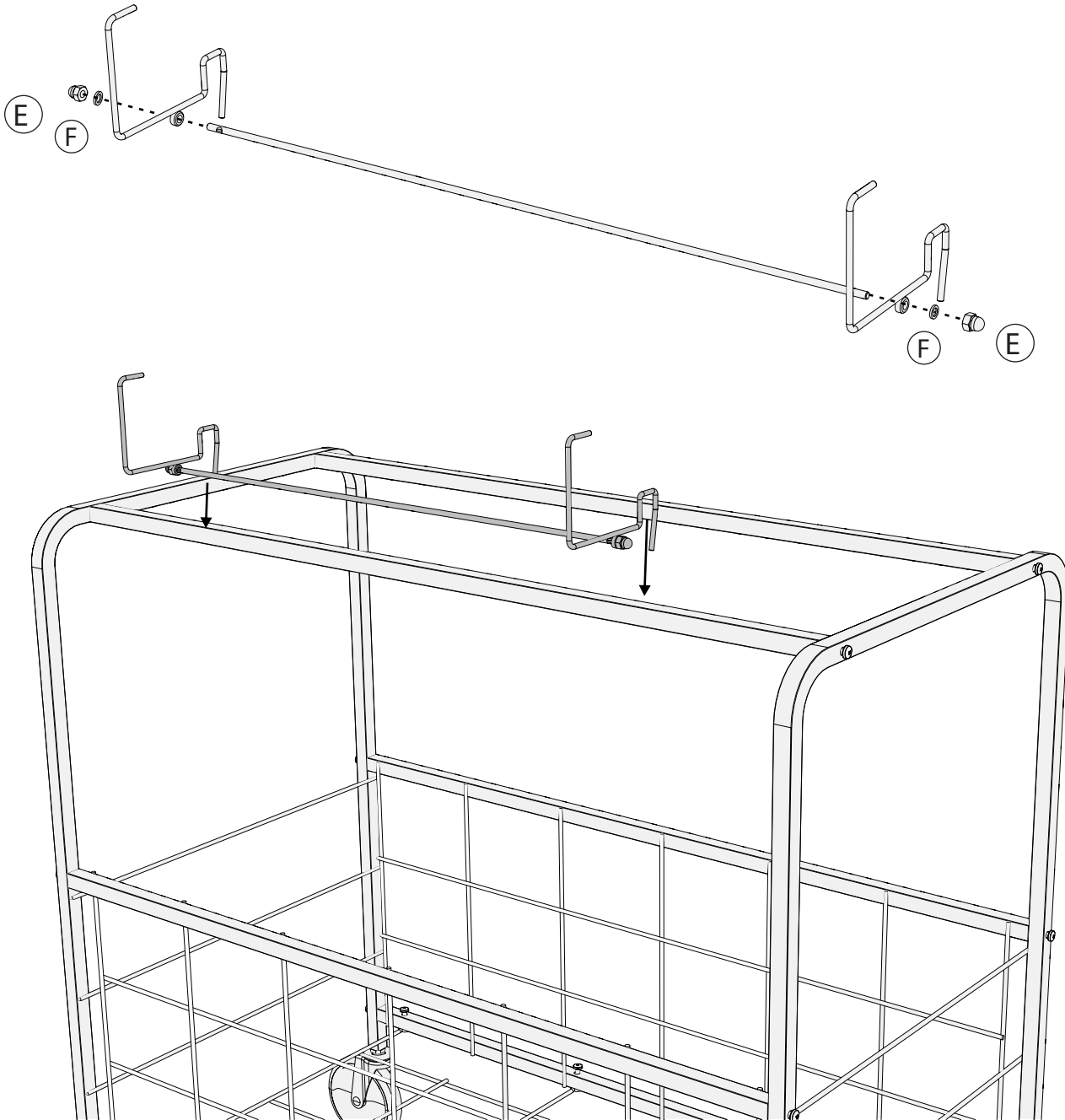

5

You will need: (Not to Scale)

Open Tub
3x

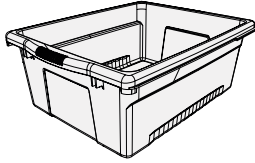

Install Open Tubs into top rack of cart

